



AGES 8+
19974/19495Asst.

Before assembly and playing, please read instructions. Please keep these instructions for future reference.

BB-50
ATTACK
STORM CAPRICORN™ M145Q



Includes 5-piece top, Ripcord Launcher™* & assembly tool.

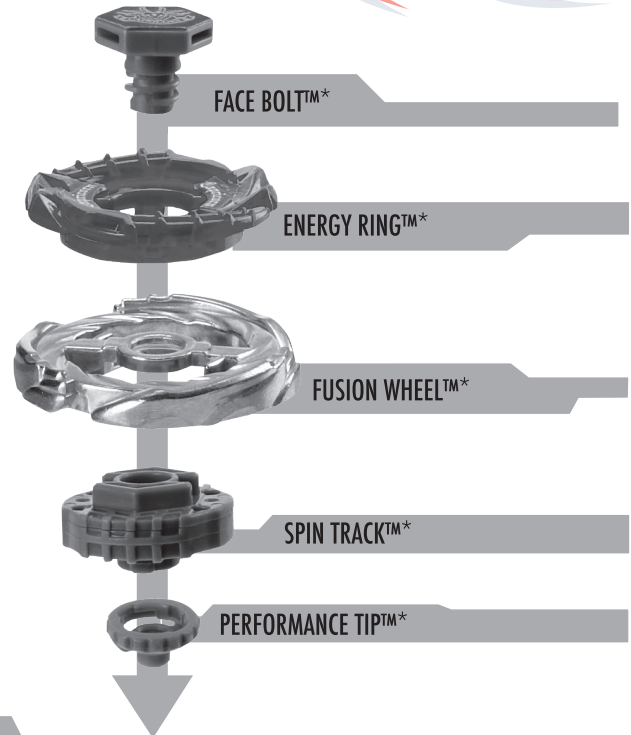

⚠ WARNING:
Do not use Beyblade™ tops or Beystadium™ (sold separately) on tables or other elevated surfaces.

APPLY LABELS AS SHOWN

Remove temporary decals and apply permanent decals as shown.

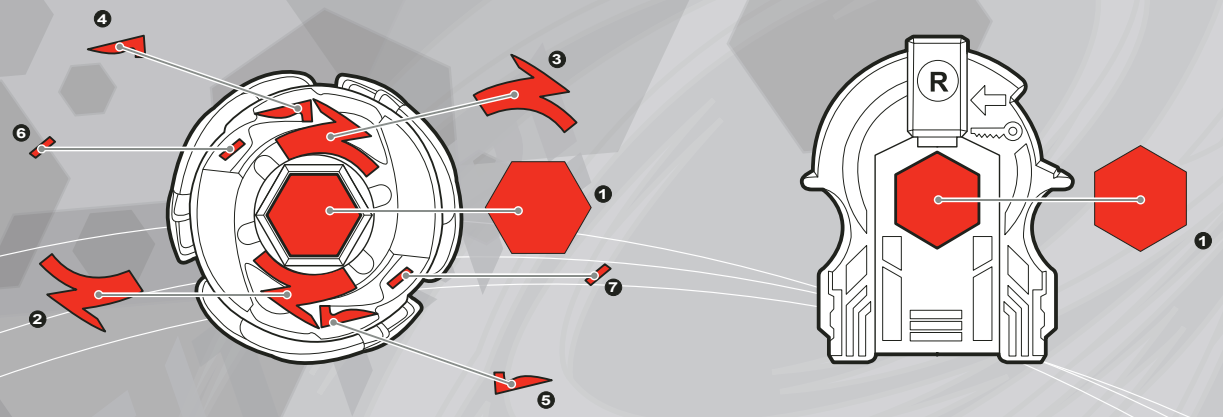

ASSEMBLY:

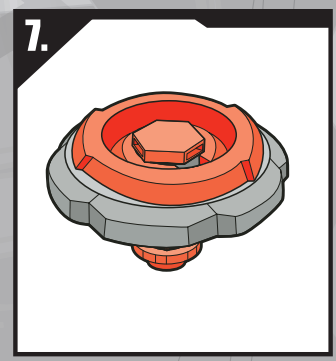
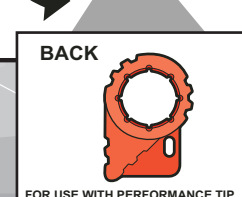
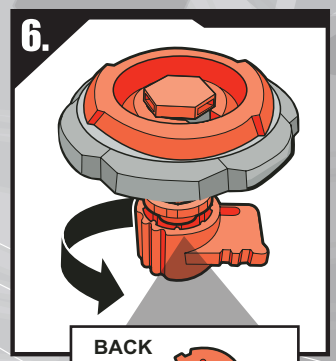
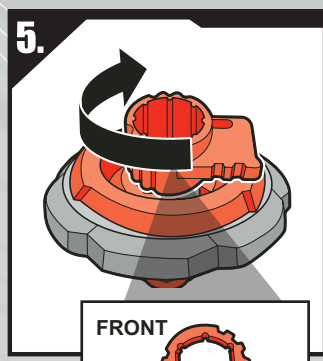
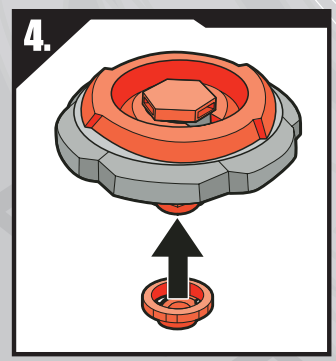
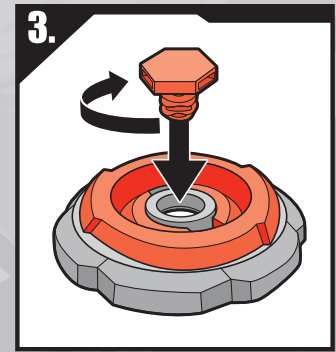
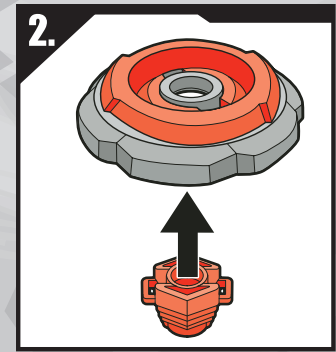
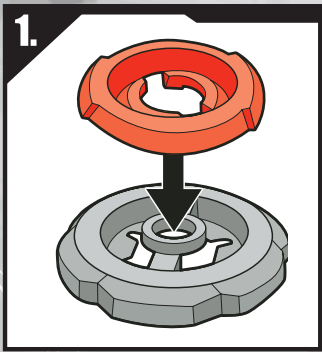

TO LAUNCH:

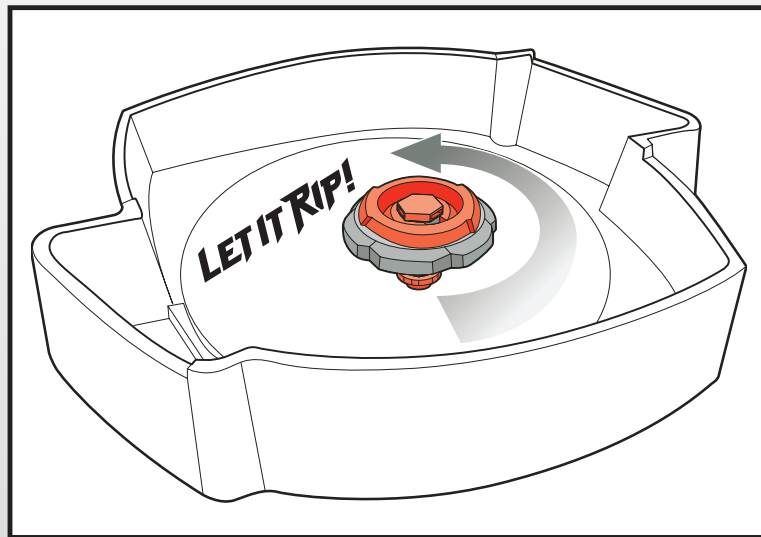
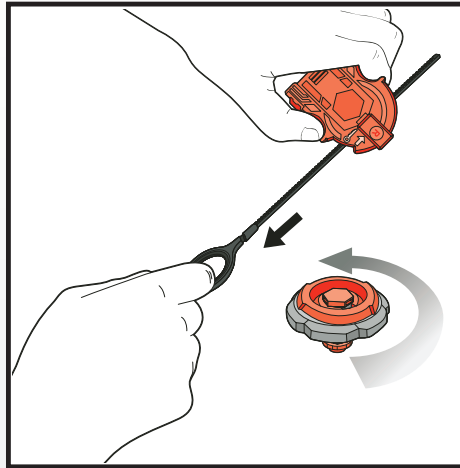
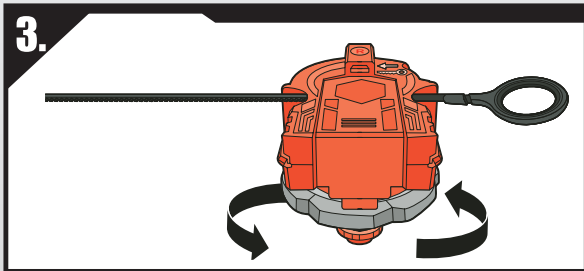
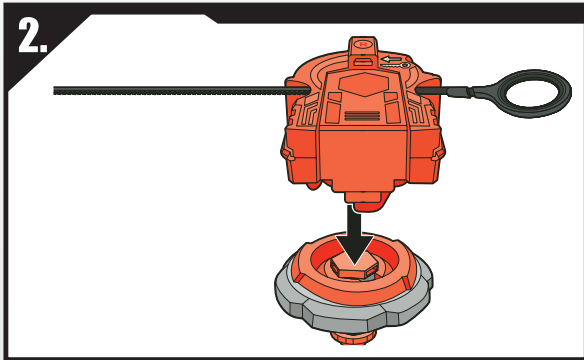
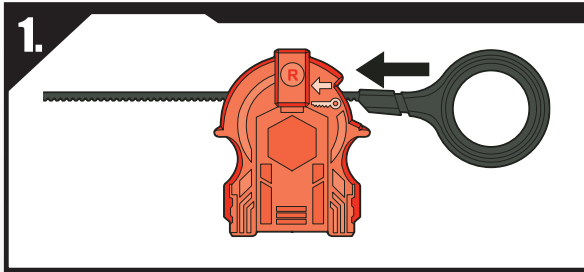

BATTLE TIPS:

Collect. Each type of top (attack, defense, stamina, balance) performs differently, so it's good to have different types. That way, you are ready to battle any top.

Customize. Customizing your tops will make them perform differently. Experiment and see how to enhance their performance by switching parts.

- What kind of top does your opponent have, and what will be the best way to defeat it? Do you need an attack top or one with stamina? Is a defense top your best option, or a top with balance?
- What kind of stadium are you using? Familiarize yourself with the different types of stadiums, so you will know which kind of top will work best in it.
- Learn more at www.BeyBladeBattles.com!†

Compete. Figure out what type of top you're battling so you can choose the best top and strategy to win.

Battle at BeyBladeBattles.com!†

TRIPLE SHOT BATTLES:

You and your opponent battle 3 Beyblade tops!

- Assemble your tops.
- Decide the order in which you'll battle them.
- Complete 3 battles.
- The player who wins 2 out of 3 battles is the winner.

†Web Site Available for a Limited Time



Product and colors may vary.
© Takafumi Adachi, MFBBProject, TV Tokyo
Manufactured under license from TOMY Company, Ltd.
®* and/or TM* & © 2010 Hasbro. All Rights Reserved.
TM & © denote U.S. Trademarks.

PN 7079780000

d-rights

